

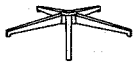











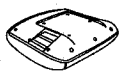





















# Assembling Instruction

(1) Base	(2) Gas Column	(3) Headrest																																				
																																						
(4) Armrest	(5) Seat	(6) Back																																				
																																						
(7) Mechanism																																						
																																						
<p>(8)</p> <table border="0"> <tr> <td>1.</td> <td></td> <td>x2</td> <td>(6x35) mm</td> </tr> <tr> <td>2.</td> <td></td> <td>x2</td> <td>(6X45) mm</td> </tr> <tr> <td>3.</td> <td></td> <td>x3</td> <td>(8X20) mm</td> </tr> <tr> <td>4.</td> <td></td> <td>x10</td> <td>(6X16) mm</td> </tr> <tr> <td>5.</td> <td></td> <td>x6</td> <td>(6X40) mm</td> </tr> <tr> <td>6.</td> <td></td> <td>x3</td> <td>(8X20) mm</td> </tr> <tr> <td>7.</td> <td></td> <td>x3</td> <td>8mm</td> </tr> <tr> <td>8.</td> <td></td> <td>x5</td> <td></td> </tr> <tr> <td>9.</td> <td></td> <td>x1</td> <td>5mm</td> </tr> </table>			1.		x2	(6x35) mm	2.		x2	(6X45) mm	3.		x3	(8X20) mm	4.		x10	(6X16) mm	5.		x6	(6X40) mm	6.		x3	(8X20) mm	7.		x3	8mm	8.		x5		9.		x1	5mm
1.		x2	(6x35) mm																																			
2.		x2	(6X45) mm																																			
3.		x3	(8X20) mm																																			
4.		x10	(6X16) mm																																			
5.		x6	(6X40) mm																																			
6.		x3	(8X20) mm																																			
7.		x3	8mm																																			
8.		x5																																				
9.		x1	5mm																																			



## A

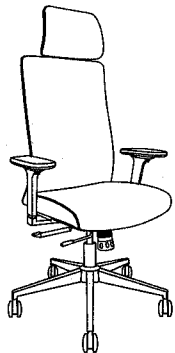
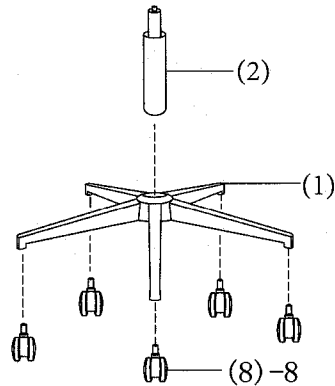

## B

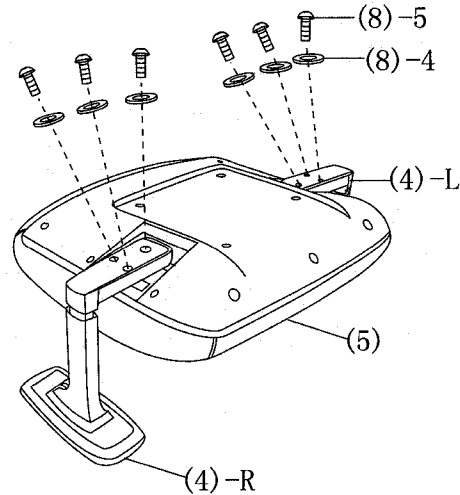

## C

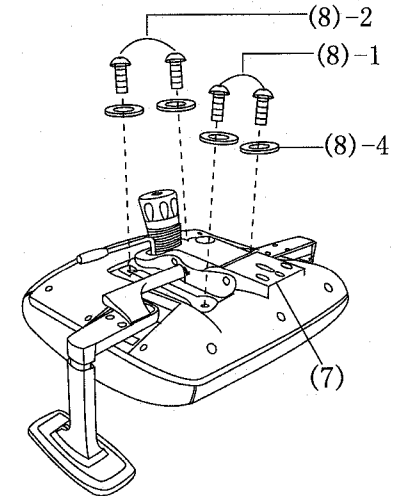

## D

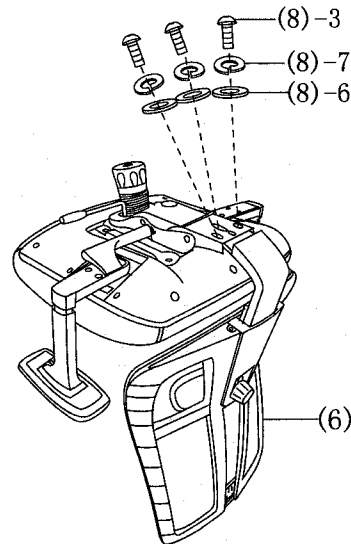

## E

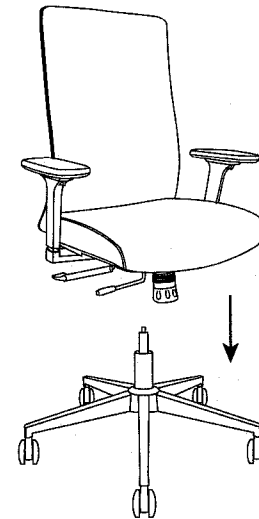

## F

